



Consolidated Sterilizers

Designed to Transform Your Laboratory

Small Lab Series Steam Sterilizers General Specifications

General Specification

Steam Sterilizer, Radial Arm Door(s), Hinged,
Single Chamber, Double Wall

Consolidated Small Lab Series Sterilizers are designed to sterilize at temperatures between 100°C to 132°C (212°F to 270°F) through the use of steam. Choose from a stainless steel or nickel-clad steel vessel construction in a variety of sizes and programmable control options for pre-vacuum or gravity operation. Consolidated Small Lab-Series Sterilizers offer a range of performance options to meet the most demanding applications in clinical, animal and life science, biotechnology, pharmaceutical, and commercial/industrial applications.

Features and Benefits

Simplified Maintenance, Low Cost of Ownership.

All Consolidated Sterilizers are manufactured in the USA and built from commonly available parts to allow quick and cost effective field-level service and maintenance.

Serviceability.

Easy access to replaceable components, local component availability and common electrical and plumbing parts permit qualified facility or area service companies to maintain the sterilizer. The radial-arm, solid-silicone door gasket is selected for durability; the gasket is easily replaced if required.

Control Flexibility.

A choice of programmable controllers allows a broad range of performance functions, complete with alarm, monitoring and communications required for internal or third-party compliance.





Performance Cycles – Basic to Advanced.

The fully-jacketed sterilizer design permits vacuum and pressure control when configured for pre-vac, post-vac, and more sophisticated functions such as air-over-pressure. Consolidated sterilizers are ideal for sterilizing wrapped and unwrapped goods, liquids, waste, and other applications. All cycles are easily managed and documented.



Green and Environmentally Friendly.

Unique, new water-saving technologies reduce water consumption without compromising performance.

Model	Size (per chamber / w x h x f-b)	Volume (per chamber)
 SSR-2A	16" x 16" x 26" 40.6 x 40.6 x 66.0 cm	3.9 cu.ft. 109 liters
 SSR-3A	20" x 20" x 38" 50.8 x 50.8 x 96.5 cm	8.8 cu.ft. 249 liters
 SR-24A	24" x 24" x 36" 61.0 x 61.0 x 91.4 cm	12.0 cu.ft. 340 liters
 SR-24B	24" x 24" x 48" 61.0 x 61.0 x 122.0 cm	16.0 cu.ft. 453 liters
 SR-26A	26" x 26" x 39" 66.0 x 66.0 x 99.0 cm	15.25 cu.ft. 340 liters



Consolidated Small Lab-Series Sterilizers are available in single door, pass-thru and dual (tower) models. A versatile control system offers a range of performance options to meet the most demanding applications in clinical, life science, biotechnology, pharmaceutical, and commercial/industrial applications. Model PT-24A-ADVPRO shown with ADV-PRO programmable logic controller.



Featuring Green Technology















for Energy Savings and Minimal Environmental Impact

Summary Selection Chart

Consolidated Small Lab Series Sterilizers are based on five chamber sizes, both single door and pass-thru, with single chamber or dual (tower) models. All doors are shown left-hinge standard. Right-hinge can be specified when ordering.

Summary Selection Chart

Model	Chamber Dimensions (w x h x f-b)	Volume (cu.ft./liters)	Ship Weight (lbs/kg)	Ship Dimensions (w x h x f-b)
Single Chamber Models				
    				
SSR-2A	16" x 16" x 26" 40.6 x 40.6 x 66.0 cm	3.9 cu.ft. 109 liters	<u>1150</u> 523	36" x 72" x 46"
SSR-3A	20" x 20" x 38" 50.8 x 50.8 x 96.5 cm	8.8 cu.ft. 249 liters	<u>1650</u> 750	36" x 72" x 57"
SR-24A	24" x 24" x 36" 61.0 x 61.0 x 91.4 cm	12.0 cu.ft. 340 liters	<u>2300</u> 1045	43" x 73" x 58"
SR-24B	24" x 24" x 48" 61.0 x 61.0 x 122.0 cm	16.0 cu.ft. 453 liters	<u>2500</u> 1136	43" x 73" x 74"
SR-26A	26" x 26" x 39" 66.0 x 66.0 x 99.0 cm	15.25 cu.ft. 340 liters	<u>2450</u> 1113	45" x 76" x 65"
Single Chamber, Pass-Thru Models				
    				
PT-SSR-2A	16" x 16" x 26" 40.6 x 40.6 x 66.0 cm	3.9 cu.ft. 109 liters	<u>1300</u> 591	39" x 74" x 58"
PT-SSR-3A	20" x 20" x 38" 50.8 x 50.8 x 96.5 cm	8.8 cu.ft. 249 liters	<u>1800</u> 819	39" x 74" x 67"
PT-SR-24A	24" x 24" x 36" 61.0 x 61.0 x 91.4 cm	12.0 cu.ft. 340 liters	<u>2650</u> 1205	46" x 75" x 68"
PT-SR-24B	24" x 24" x 48" 61.0 x 61.0 x 122.0 cm	16.0 cu.ft. 453 liters	<u>2850</u> 1295	46" x 75" x 84"
PT-SR-26A	26" x 26" x 39" 66.0 x 66.0 x 99.0 cm	15.25 cu.ft. 340 liters	<u>2800</u> 1273	51" x 77" x 71"
Dual Chamber Tower Models				
 				
2SSR-2A	16" x 16" x 26" 40.6 x 40.6 x 66.0 cm	3.9 cu.ft. 109 liters	<u>2250</u> 1125	43" x 87" x 61"
2SSR-3A	20" x 20" x 38" 50.8 x 50.8 x 96.5 cm	8.8 cu.ft. 249 liters	<u>3250</u> 1477	43" x 87" x 61"

High Performance Sterilization

Consolidated Small Lab-Series Steam Sterilizers are used in a wide range of applications including clinical, animal and life science, biotechnology, pharmaceutical, and commercial/industrial markets. Consolidated sterilizers are suitable for conventional or pre-vacuum sterilization for quality control, safety and regulatory compliance. In addition, all units can be customized to suit any unique requirements and applications of a particular facility.

Consolidated uses only commonly-available, open source parts in all phases of sterilizer design and construction, thereby permitting quick, economical and locally-managed service

throughout the life of the product. With maximum uptime engineered into the product, Consolidated sterilizers offer a superior return on investment as demonstrated through thousands of installations worldwide.

Sterilization Cycles, Functional Performance

Consolidated steam sterilizers can be easily configured for numerous cycles and functions. Each cycle is customizable to meet user specific requirements. All cycle parameters are easily viewed prior to and during the cycle run. The following cycles are pre-configured and installed on all gravity and pre-vacuum sterilizers:

Gravity. (figure 1)

Available on gravity and pre-vacuum units. The gravity cycle uses gravity to displace the air in the chamber with pressurized steam. This cycle is used mainly for unwrapped goods. The operator may select a sterilization temperature anywhere between 212°F (100°C) and 270°F (133°C), as well as sterilization time and dry time.

Liquids. (figure 2)

Available on gravity and pre-vacuum units. The liquid cycle prevents boil-over when vented liquids are sterilized. The controller is factory-configured to automatically release steam pressure at an adjustable exhaust rate. The operator may select a sterilization temperature anywhere between 212°F (100°C) and 270°F (133°C), as well as sterilization time.

In addition to the Gravity and Liquids Cycles, all pre-vacuum sterilizers are preconfigured to also include the following cycle:

Pre-Vacuum. (figure 3)

Available only on pre-vacuum units. This cycle performs a series of steam pulses and vacuum draws prior to sterilization to assure that air has been removed from the load. This also permits the ability to vacuum dry. The number of pulses, pulse steam pressure, vacuum pulse pressure, sterilization time and temperature, and dry time are customizable for each cycle.

Additional Sterilization Cycles (available upon request)

Gravity with Post-Vacuum. (figure 4)

Available on gravity and pre-vacuum units. A post-vacuum (or drying) cycle draws a vacuum following sterilization and significantly decreases drying time. This cycle is usually used for wrapped goods, fibers, rubber, bedding and similar loads. The operator may select a sterilization temperature anywhere between 212°F (100°C) and 270°F (133°C), as well as sterilization time and dry time.

Liquids with Load Probe.

Available on gravity and pre-vacuum units. This cycle uses a temperature probe placed within the liquid load to detect, display and print temperature. Applications include sterilization of temperature-sensitive liquids or large volume liquid sterilization (i.e. >2 liter flasks).

Bowie Dick (Air Removal Test).

Available on pre-vacuum units. This air-removal test cycle validates the vacuum function using ad hoc test packs as per requirements listed in AAMI ST-8.

Vacuum Leak Test.

Available on pre-vacuum units. This cycle provides easy verification of vacuum depth, vacuum seal and chamber piping integrity. Detects leaks greater than 1 mm-Hg (1 Torr) per minute.

Effluent Decontamination.

Available on gravity and pre-vacuum units. Retains liquid effluent, if any, within the chamber for the duration of the sterilization cycle. Aerosol effluent passes through a 0.20 micron hydrophobic HEPA filter with >99.999% efficiency; the filter is located within the chamber and is sterilized in situ to eliminate the need for disposal after each cycle. The filter is easily replaced by the user when required without special tools or service personnel.

Air-Over-Pressure. (figure 5)

Available on gravity and pre-vacuum units. This cycle uses compressed air to maintain chamber pressure at the sterilization pressure until the liquid has cooled to 212°F (100°C). The rate of exhaust is adjustable. This is useful for small volumes of liquid susceptible to boil-over.

Low Temperature.

Available on gravity and pre-vacuum units. Typically used for temperature-sensitive goods, this function creates a zero-pressure, temperature only cycle between 190°F and 212°F.

Rapid Cooling.

Available on gravity and pre-vacuum units. Useful for rapidly cooling liquid media via an interior water spray mechanism, post-sterilization.

F₀ Cycle.

Available on gravity and pre-vacuum units. Useful for heat-sensitive liquid media.

Pressure Ramping.

Available on gravity and pre-vacuum units. Allows the user to specify a.) the amount of time it takes for the load to rise to sterilization temperature/pressure and b.) the amount of time it takes to exhaust the sterilizer chamber post-cycle. Ideal for loads that are sensitive to rapid pressure changes.

Compliance and Certifications

Depending on desired application, Consolidated steam sterilizers can be certified for compliance to the following standards for performance and safety. Selected models qualify as a medical device by the FDA.

- ASME (American Society of Mechanical Engineers): Section VIII, Division I (Unfired Pressure Vessel) code.
- ASME: Section I Code (Power Boilers).
- CRN (Canadian Registration Number): requirements for pressure vessels.
- IEC (International Electrotechnical Commission):
 - EN 61010-1:96 - Safety requirements for electrical equipment for measurement, control, and laboratory use.
 - EN 61010-2-041:96 - Specific requirements for steam autoclaves.
- UL and cUL (Underwriters Laboratory): Standard 61010-1 and 61010-2.
- US NEC (National Electrical Code): and National Plumbing Code.
- EN ISO 111345-R-8/93 - (Association for the Advancement of Medical Instrumentation - AAMI) Industry Standard for Moist Heat Sterilization.
- 21 CFR Part 11 (US Code of Federal Regulations, Section 21 - Food and Drugs; Electronic Records; Electronic Signatures.).
- ANSI/AAMI ST-8: Hospital Steam Sterilizers.

Sterilizer Cycle Selection

Gravity. (figure 1)

Steam flows through the sterilizer; temperature and pressure ramps slightly to a continuous flow purge.

The controller closes the exhaust valve and interior temperature and pressure ramp up to desired setpoint.

The program maintains dwell until desired time is reached, when pressure is released.

The interior is restored to ambient pressure although contents remain relatively hot.

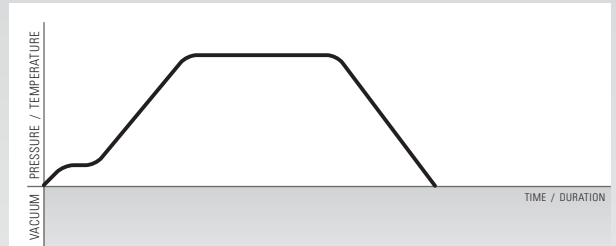

Liquid. (figure 2)

Steam flows through the sterilizer; temperature and pressure ramps slightly to a continuous flow purge.

The controller closes the exhaust valve and interior temperature and pressure ramp up to desired setpoint.

The program maintains dwell until desired time is reached.

Pressure is gradually released to allow dissolved gases to reach equilibrium to prevent boilover.



Pre Vacuum with Post Vacuum Drying. (figure 3)

Steam flows through the sterilizer; temperature and pressure ramps slightly to a continuous flow purge.

The controller closes the exhaust valve and interior temperature and pressure ramp to an intermediate setpoint without dwell.

A vacuum system draws the interior atmosphere to negative pressure to remove latent air from concealed pockets within the load.

The process is repeated per program and protocol. Following the final pre-vacuum pulse, the sterilizer ramps to desired setpoint.

The program maintains dwell until desired time is reached, when pressure is released.

If a post vacuum program is used, a vacuum system draws the interior atmosphere through ambient to negative pressure, accelerating drying time as programmed, after which the vacuum is released and the load is restored to ambient pressure.

If a post vacuum program is not used, the load is restored to ambient pressure.

Sterilizer Cycle Selection (Continued)

Pre Vacuum with Post Vacuum Drying. (figure 3)

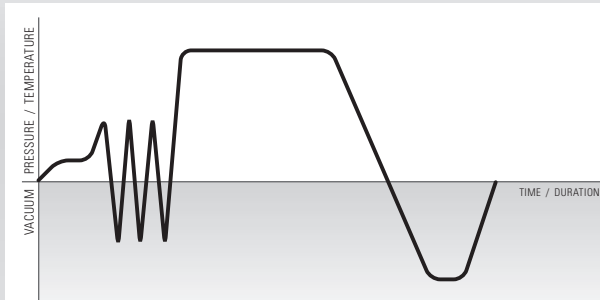

Gravity with Post Vacuum Drying. (figure 4)

Steam flows through the sterilizer; temperature and pressure ramps slightly to a continuous flow purge.

The controller closes the exhaust valve and interior temperature and pressure ramp up to desired setpoint.

The program maintains dwell until desired time is reached, when pressure is released.

A vacuum system draws the interior atmosphere through ambient to negative pressure, accelerating drying time as programmed.

Once completed the vacuum is released and the load is restored to ambient pressure.

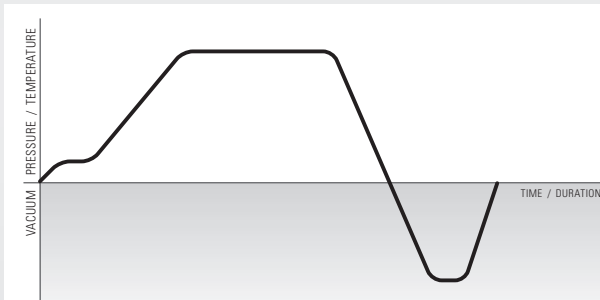

Liquid, Air-Over-Pressure. (figure 5)

Usually used with smaller amounts of media to prevent liquid loss.

The Air-Over-Pressure function operates identical to the liquid cycle except that pressurized air is injected to cool the load while maintaining pressure to displace steam.

After sterilization, air is injected, pressure is maintained, this prevents boilover and minimizes evaporation.

Air pressure is then released and the load is restored to ambient pressure.

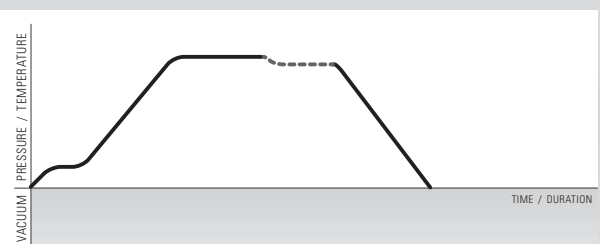

Heavy-Duty Construction

Sterilizer Chamber.

Consolidated steam sterilizer vessels are manufactured with an inner chamber and a full outer jacket. The inner chambers are available in either Type 316L stainless steel or nickel-clad steel construction. Jacket construction is available in either carbon steel, Type 304L stainless steel or Type 316L stainless steel. Material selection is directly related to the chemical properties of available water supply and intended application. Pressure vessels are welded in compliance with ASME Section VIII, Division I.

Chamber Door and Gasket System.

Consolidated's sterilizer doors are designed with redundant, and independent mechanical and software features to ensure maximum safety. Door design specifications meet all ASME code requirements.

- Multiple door arms assure that, in the event of a failure of any one arm, the door will continue to support the load within performance specifications.
 - Door engagement is clearly visible to confirm closure.
 - An electrical door switch ensures that the door is fully closed and locked prior to the start of the cycle. If the signal is lost during a sterilizing cycle, the cycle is automatically aborted.
 - The door pressure clutch assembly is activated by chamber pressure to lock the door. Chamber pressure forces a membrane against the clutch plate, engaging the lock to permit tightening, but not loosening of the door.
 - As the handle is turned to the closed position, the latching arms extend out into the door end-frame. Full rotation of the door handle presses the door against the chamber sealing surface thereby compressing the seal, and activating the electrical door limit switch.
 - Consolidated autoclaves use solid silicone gaskets that do not require high pressure air, steam or vacuum to operate. Instead, the act of closing the door compresses the silicone gasket to create a secure and reliable seal. In the event that the gasket fails, the door can still be easily opened and the gasket quickly replaced.
 - Pass-thru (double door) sterilizers may be ordered with optional door interlocks. The electro-mechanical lock on each door minimizes the chance of cross-contamination between contained and uncontained areas by preventing both doors from being opened simultaneously. This lock operates independently of the controller so that a software or electrical malfunction cannot cause cross-contamination.
- ### Components.
- Piping, fittings, and valves are available in stainless steel or brass/bronze. All parts and components subject to repair are publicly available (i.e. non-proprietary) from open market sources, including controls, valves and fittings.
 - Safety relief valves and drains are integral to the plumbing configuration.
 - Baffled steam inlets minimize direct condensate on the load, reduce load wetting, and help assure proper steam uniformity within the chamber.
 - Cabinet insulation retains heat and minimizes heat loss to the room. The sterilizer jacket and all steam service piping include a minimum 1" fiberglass-based insulation.
 - An integral wastewater cooling function reduces discharge temperature to the drain to less than 140°F.

- An ASME CSD-1 pressure switch is included to back up the safety relief valve by automatically shutting down the steam generator if an overpressure condition exists.
- Easy-to-read pressure gauges ensure simple and safe operation.
- Other components required for the intended application may include a steam generator, vacuum pump, water ejector, etc. depending on the options chosen.

Air Removal

Depending on the application and required cycle, air removal may be achieved by gravity displacement or mechanical assistance through vacuum for pre- and post-cycle use as required.

- For gravity air removal, the control system automatically opens and closes valves on demand.
- For pre-cycle vacuum, Consolidated offers a choice of a water-ejector vacuum system, or a water-minimizing liquid ring vacuum pump.
- For post-cycle vacuum where drying assistance is desired, the sterilizer can use a water-ejector vacuum system, that utilizes the sterilizer water supply, or a water-minimizing liquid ring vacuum pump.
- Following completion of the post-vacuum function and throughout return to ambient pressure equilibrium, the returning air is filtered through a 0.3 micron bacteria-retentive filter.

Control and Monitoring System (Chart, Page 6)

Consolidated offers a variety of control system options for programmed, automatic and semi-automatic operation. Controllers are built from industry standard, open source components for international availability of parts and service. Consolidated's Advantage Series™ controllers offer proven reliability. Controllers are based on the Allen Bradley PLC platform specifically for Consolidated Sterilizers, complete with intuitive Rockwell touch-screen displays and real-time operating systems.

- Permits industry standard and custom sterilizer cycles.
- Simplifies operation with intuitive operator interfaces.
- Assures quality control and process integrity.
- Features sterilizer cycle quality reporting and printed documentation.
- Audible and visual alarms warn of cycle or other deviations.

Printer.

An impact printer or thermal printer can be integrated into the main control panel. Printout includes all important information regarding the sterilization cycle recorded at user-defined intervals. Information includes: operator identification code, cycle type, cycle stage, time, chamber and jacket pressure and/or temperature, alarms or messages and cycle completion status.

Alarms.

Detailed performance and function alarms are based on the control system selection. Regardless of control system used, however, standard safety alarms are included in all Consolidated steam sterilizers.

Cycle Safeguards.

Depending on the controller selected, a range of cycle safeguards helps assure safe operation.

- No cycle can start unless the door is properly closed and locked.

- Control inputs automatically reject incorrect cycle parameters.
- Chamber gauges are installed on the operating end of the sterilizer to display pressure in PSIG and vacuum in inches-Hg.
- Exhaust is automatically condensed and cooled to a safe drainage temperature.
- Manual adjustment of condensing water flow offers economy in water consumption and lower operating costs.

Calibration.

Sterilizers can be calibrated by a two-point software method on all sensor circuits. In this process, atmospheric transducer readings will be acquired and chamber transducers are offset at an equal level.

Steam Sources

Consolidated steam sterilizers can operate on house steam or steam produced by integral or remote steam generators. Incoming water quality is always a primary consideration in selection of a steam generator.

Selection of the steam source is based on facility steam availability and other factors associated with sterilizer use and throughput.

- House Steam Option

In most situations standard house steam, when available is adequate. An inlet filter may be required to clean the steam prior to injection into the sterilizer plumbing system.

- Electric Steam Generator

When house steam is not available, an integrated or remote boiler must serve as the steam source. Higher wattage generators produce a higher rate of steam to the chamber.

Integrated Boiler. Consolidated can provide an integral (fits under the sterilizer chamber) steam generator up to 39kw.

A standard steam boiler, constructed of carbon steel, is utilized on units fed with tap or softened water.

A clean steam boiler, constructed of stainless steel, is recommended when the water quality feed is >1 MegaOhm/cm. This option typically requires that the sterilizer be constructed with a stainless steel chamber, jacket, and plumbing.

Remote Boiler. Steam generators >39 kw are typically too large to fit beneath the sterilizer chamber and must be remote mounted.

Voltages. Standard voltages available are 208, 240, 380, 480. Three-phase or single-phase connections must be determined before boiler selection to accommodate generator heating elements.

- Steam to Steam Generator

A steam-to-steam generator offers another steam option to deliver clean steam to the chamber. Contact Consolidated for details and ordering information.

- Generator Blowdown Option

In facilities where water quality is poor, a generator blowdown function is required to flush impurities from the system and prevent collection of contaminants on the heating elements. The blowdown function can be initiated manually or ordered as an Automatic Blowdown function if desired.

Consolidated Still and Sterilizers Controller Options— The Advantage Series™ Programmable Logic Controllers

Catalog Number	ADV-PRO	ADV-PLUS	ADV-PB
Description	Color touch screen display	Monochrome touch screen display	Monochrome touch screen display

Operator Interfaces

Display	6" - 18 bit Color	10" - 18 bit Color	6" - Monochrome	3" - Monochrome
Resolution	320 x 240 pixels	640 x 480 pixels	320 x 240 pixels	128 x 64 pixels
Mounting Options	Swing-Arm, Front Panel and Remote Panel		Front Panel and Remote Panel	Front Panel and Remote Panel
Chamber Process Gauges	Pressure (Psig, kg/cm ²) Vacuum (inHg, mmHg)		Pressure (Psig, kg/cm ²) Vacuum (inHg, mmHg)	Pressure (Psig, kg/cm ²) Vacuum (inHg, mmHg)
Dual Control Display for Pass-thru Models	Optional			
Remote Cycle Start Switch for Pass-thru Models	Optional		Optional	Optional

Industry Standard and Custom Sterilizer Cycles

Gravity	Yes	Yes	Yes
Fluid w/Auto Jacket Blowdown	Yes	Yes	Yes
Pre-Vacuum	Optional	Optional	
Post-Vacuum	Optional	Optional	Optional
Low Temperature	Optional	Optional	
Bowie-Dick (Air Removal Test)	Optional		
Vacuum Leak Test	Optional		
Air-Over-Pressure	Optional		
Effluent Decontamination	Optional		
Total Programmable Cycles	Up to 20, maximum	Up to 6, maximum	Up to 2, maximum

Green Features

Energy Saver Calendar for Scheduled On/Off Steam Supply	Optional	Optional	Optional
Water Eco System for Reduced Water Consumption	Optional	Optional	Optional

Configurable Cycle Parameters	Standard	Standard	Standard
Improper Parameter Rejection	Standard	Standard	Standard
Multi-Layered Password Security for Configuration Protection	Standard		
Two Point Calibration of Sensors	Standard	Standard	Standard
Door Interlock to Prevent Inadvertent Cycle Start ¹	Pass-thru Models Only	Pass-thru Models Only	Optional Audible Warning Only
Automatic Condensate Exhaust Management for all Cycles	Standard	Standard	Standard
Memory Backup of Configuration	Standard	Optional	Optional
Fully Integrated SCADA system	Standard	Optional	Optional

Sterilizer Cycle Quality Reporting

Graphic Display of Cycle Progress	Standard	Standard	Standard
Thermal Printer (48 Chars/line)	Optional	Optional	
Impact Printer (48 Chars/line)	Standard	Standard	Optional
Ethernet	Standard		
RS-232	Optional	Optional	
RS-485	Optional	Optional	
Fully-Integrated SCADA system	Optional	Optional	Optional

Printed Documentation of Sterilizer Cycles

User Defined Cycle Name	Yes		
Start Time and Date	Yes	Yes	Yes
Cycle Type	Yes	Yes	Yes
Chamber Temperature/Pressures	Yes	Yes	Yes
Cycle Summary	Yes	Yes	Yes

Audible Alarms (also displayed on touch screen)

Cycle Completed; Recycle Alarm; Over Temperature Alarm; Over Pressure Alarm; Time Limit Alarm; Chamber Drain Alarm; Jacket / Chamber Flow Failure	Standard	Standard	Standard
---------------------------------------------------------------------------------------------------------------------------------------------------	----------	----------	----------

¹ Optional audible warning buzzer available; contact Sales for information.

For information about controllers required for FDA applications contact Consolidated Sterilizers direct.

Sterilizer Installation

Consolidated Small Lab Series sterilizers are available for installation as floor-standing cabinet-enclosed units with a stainless steel superstructure to conceal plumbing and wiring. These sterilizers are also available for installation as recessed in one or two walls. Hook-ups for utility connections can be located anywhere on the unit as required, however house connections must be within 5 feet of the unit unless otherwise specified prior to installation.

For Biological Safety Level 3 installations a Bioseal® can be installed to maintain the contamination integrity of the clean side. Utilities can be mounted at the non-contained side of the installation and in the front, rear or designated side of the cabinet.

Shelving

Shelves, carts and other accessories are available to suit specific applications. Shelves and racks are constructed of electro-polished Type 316L stainless steel. Interior shelving options include:

- Standard: One (1) stationary full-length wire-grid bottom shelf and one (1) upper stationary shelf suspended in the middle of the chamber on shelf brackets.
- Option 1: One (1) stationary full-length wire-grid bottom shelf and one (1) upper extendable shelf suspended in the middle of the chamber on shelf brackets.
- Option 2: One (1) stationary full-length wire-grid bottom shelf and two (2) upper extendable shelves suspended in the middle of the chamber on shelf brackets.
- Option 3: A loading cart, mounted on rollers, with two stainless steel shelves and a wheeled transfer carriage. The transfer carriage mates to interior guide rails to ease loading and unloading of sterilization loads up to 500 lbs evenly distributed.



Options and Accessories

Consolidated offers a range of options and accessories to optimize and customize your sterilizer, to meet requirements for internal or third-party compliance, and to improve workflow. Some options are factory installed and must be specified when ordering. Contact Consolidated for detailed information on any of the following.

Validation Documentation.

Protocols and templates are available for Factory Acceptance Testing (FAT), Installation Qualification (IQ), Operation Qualification (OQ), and Performance Qualification (PQ) in accordance with 21 CFR (US Code of Federal Regulations, Section 21 - Food and Drugs) Part 11.

RS-232 Port.

Connects the control system to data logging/monitoring equipment. Factory installed. Specify when ordering.

RS-485 Port.

Connects the control system to data logging/monitoring equipment. Factory installed. Specify when ordering.

Temperature Probe Sealing Gland.

Multi-port gland permits safe installation of thermocouples or other probes inside the chamber. Factory installed. Specify desired quantity and location when ordering.

Validation Port.

Required for insertion of thermocouple(s) to chamber interior for temperature profiling and validation. Ports are located on the left side of the chamber and range from ½" to 2" diameter; specify when ordering.

SteriNET™ Remote Troubleshooting.

The SteriNET™ remote troubleshooting option permits Consolidated engineers to provide quick, accurate and economical offsite diagnosis of operation problems through a standard phone line. This option includes one year of free, remote transmitted software upgrades from the Consolidated technical support center. If problems are confirmed and parts are needed, diagnostics permit advanced, expedited acquisition or shipment of parts for on-site service to minimize downtime. SteriNET™ also assists Consolidated technical service in answering routine questions about your sterilizer.

Seismic Mounting Brackets.

Required to meet certain local codes in seismically active areas. Contact your facility manager for information. Factory installed. Specify when ordering.

Effluent Decontamination Control.

Exclusively from Consolidated, this effluent decontamination system traps bacteria within the autoclave chamber and sterilizes it prior to release into the drain (Consolidated Patented Process). Any liquid effluent is held in the chamber for the duration of the sterilization cycle. All aerosol effluent passes through a 0.2 micron hydrophobic HEPA filter with 99.999% or greater efficiency. The steam that sterilizes the products in the chamber also sterilizes the bacteria held by the filter. Filters are easily changed after use. Factory installed; specify when ordering.

Low-Temp Control.

Often referenced as an "isothermal" or "inspiration" cycle, a low temperature control is recommended when sterilizing heat-sensitive loads. In this application the sterilizer operates at a relatively low temperature and pressure. Factory installed. Specify when ordering.

Load Probe, Controlling.

Includes a temperature probe with lead wire permitting placement in the load to be sterilized such as liquid, red-bag or other. Sterilization cycle time is based on load temperature instead of chamber temperature. Factory installed. Specify when ordering.

Load Probe, Non-Controlling.

Includes a temperature probe with lead wire permitting placement in the load to be sterilized such as liquid, red-bag or other. User can monitor the temperature of the load during a cycle. Factory installed. Specify when ordering.

Steam Generator.

For installations where house steam is not available, a variety of integral or remote mounted steam generators is available. Consolidated will assist with selection according to site preparation requirements. Generators are available in electric, gas or steam-powered configurations. Integral generators are factory installed and must be specified when ordering. Contact Consolidated for ordering information.

Automatic Generator Blowdown.

Recommended to remove accumulated impurities from the steam generator when used with low quality incoming water. Factory installed. Specify when ordering.

Automatic Jacket Blowdown.

Recommended for liquid cycles. This option is used to exhaust steam in the chamber as well as the jacket to prevent liquid loads from boiling over. Factory installed. Must be specified when ordering. Contact Consolidated for ordering information.

Steam Inlet Filter.

Recommended to clean dirty steam from common facility steam sources.

Flood Switch.

In the event of excessive liquid in the chamber or jacket, an alarm will sound and a message will be displayed warning the user about the flood condition. Factory installed. Specify when ordering.

Water Feed Pump.

Required to boost water feed pressure to the steam generator if water pressure is below 60 PSIG. Factory installed. Specify when ordering. Contact Consolidated for proper matching to selected steam generator.

Bioseal® Biological Sealing Flange.

The Bioseal® biological sealing flange required for Biological Safety Level-3 applications is welded to the periphery of the sterilizer before recessing to prevent the passage of airborne microorganisms from the hot side of the sterilizer to the cold side. A closed-cell gasket secures the seal and permits normal expansion and contraction. Choose from stainless steel or carbon steel. Factory installed. Specify when ordering. Contact Consolidated for information.

Vermin Seal.

Similar to a Bioseal®, the vermin seal is welded to the periphery of the sterilizer before recessing to prevent rodents from compromising the installation. Factory installed. Specify when ordering. Contact Consolidated for information.

Dual Controls.

For pass-thru models only. Provides touch-screen controls mounted on each end of the unit for operation from within or outside the containment area. Printer, if included, located outside containment area only unless otherwise specified.

Chamber Finish.

- High polish, less than 10RA
- Passivation and Electropolish

Stainless Steel Piping.

- Full: Type 316 stainless steel for all wetted piping.
- Partial: Type 316 stainless steel for wetted components from the steam generator to chamber inlet only.

Sump Pump.

Required when gravity drain is not available. Provides positive pump to remove condensate effluent to hard-plumbed drain.

Form C Dry Contacts.

Choose from 0-5V, DC or 4-20ma output. Offers direct connection to building monitoring system. Specify desired outputs when ordering.

RO/DI Water Purification System.

A high-purity water system is available for facilities that don't meet the minimum water purity requirements (see Table 4). A continuous flow reverse osmosis (RO) water filtration system designed to pre-treat water to the autoclave or for general laboratory use can be supplied.

WaterEco™ Water Saving Systems

The Consolidated WaterEco™ Water Saving Systems reduce water consumption to the autoclave by up to 99%. Available on

gravity and pre-vacuum units in the following configurations:

- **WaterEco Gravity Basic:** Reduces water by up to 90% without the use of electricity.
- **WaterEco Gravity Plus:** Choose this feature if facility chilled-water circulation system is readily available. This option reduces water usage by up to 99%.
- **WaterEco Vacuum Basic:** Steam sterilizer vacuum systems require a relatively high flow of cold water to function properly. This option reduces water consumption up to 50% on pre-vacuum sterilizers.
- **WaterEco Vacuum Plus:** Choose this feature if facility chilled-water circulation system is readily available. The full recovery system reduces waste water from the vacuum system by up to 99%.

Water Quality Compatibility, Stainless Steel vs. Non-Stainless Selection

Materials that contact the water supply to the sterilizer, including the steam generator, water-cooled devices, water-actuated accessories, valves and piping must be compatible with the purity of the water.

- If deionized or distilled water or water with a purity greater than 1 MegaOhm/cm is supplied, then all such points of contact must be of stainless steel construction.
- If softened water, water purified by reverse osmosis or tap water with purity of less than 1 MegaOhm/cm is supplied, then such points of contact must be of carbon steel, bronze or brass construction, as appropriate.
- Materials that contact the steam supplied to or generated by the sterilizer, including the sterilizing chamber, valves and piping must be compatible with the purity of the steam.

If the steam is generated from deionized or distilled water or water with purity greater than 1 MegaOhm/cm, then all such points of contact must be of stainless steel construction.

Site Preparation and Utilities

Utilities of ample capacity required for operation of the sterilizer shall be provided at the place of installation at the facility. Key considerations include electric power availability, steam source, water type and flow capacity, and compressed air (if air-over-pressure cycle is desired). For information on required utilities and locations refer to the sterilizer architectural drawing.

- Effluent drain and exhaust considerations include wastewater and the facility air exhaust system.
- Clearances include door and cart allowances, minimum 18-24" for access to plumbing, adequate load-bearing capacity of floor at installation site, and biointegrity.
- Contact Consolidated or your Consolidated sales representative for planning and selection assistance.

Installation Options

Consolidated offers a choice of installation options to accommodate the facility schedule. In general, Consolidated can arrange for any of the following installation preferences:

- Consolidated turn-key installation, complete.
- Consolidated on-site supervision of facility designated labor.
- Inside delivery is available, with an additional option of removal of shipping and crating materials. Contact Consolidated for details.

Table 1, Comparative Heat Loss (Per Chamber)

Model	Size (inches)	Heat Source Options	Maximum Operating Weight (lbs) ¹		Peak Heat Loss BTU/hr at 70°F								
					Single Door	Double Door	Single Door			Double Door Pass-Thru			
							Cabinet	Recessed		Recessed One Wall		Recessed Two Walls	
								To Room	Front of Wall	Back of Wall	Front of Wall	Back of Wall	Front of Walls
SSR-2A	16" x 16" x 26" 40.6 x 40.6 x 66.0 cm	Steam	1210	1310	4300	1600	2700	1600	3500	1600	1900		
		Electric	1385	1485	6050	2300	3750	2300	4550	N/A	N/A		
SSR-3A	20" x 20" x 38" 50.8 x 50.8 x 96.5 cm	Steam	1800	1950	7000	2500	4500	2500	5300	2500	2800		
		Electric	1975	2125	8750	3300	5450	3300	6250	3300	2950		
SR-24A	24" x 24" x 36" 61.0 x 61.0 x 91.4 cm	Steam	2500	2700	8890	3000	5890	3000	6690	3000	3690		
		Electric	2675	2875	11140	3800	7340	3800	8140	3800	4340		
SR-24B	24" x 24" x 48" 61.0 x 61.0 x 122.0 cm	Steam	2750	2950	11330	4000	7330	4000	8130	4000	4130		
		Electric	2925	3125	13580	4800	8780	4800	9580	4800	4780		
SR-26A	26" x 26" x 39" 66.0 x 66.0 x 99.0 cm	Steam	2700	3050	11950	4300	7650	4300	8450	4300	4150		
		Electric	2875	3225	14200	5100	9100	5100	9900	5100	4800		

¹Note: For Dual (Tower) models contact Consolidated for additional information.

Table 2, Water Consumption (Per Chamber)

Model	Size (inches)	Air Removal Method	Water Consumption							
			Cold Water				Hot/Treated			
			Peak (gpm)	Per Cycle ² (gal/cycle)	Per Cycle w/ Water Eco ³ (gal/cycle)	Idle (gph)	Idle w/Water Eco (gph)	Peak (gpm)	Per Cycle ² (gal/cycle)	Idle (gph)
SSR-2A	16" x 16" x 26" 40.6 x 40.6 x 66.0 cm	Gravity	6	7	1	5	1	1	3	1
		Ejector	6	135	130	5	1	1	3	1
		Vacuum	6	35	30	5	1	1	3	1
SSR-3A	20" x 20" x 38" 50.8 x 50.8 x 96.5 cm	Gravity	6	15	1	7	1	1	4	1
		Ejector	6	145	130	7	1	1	4	1
		Vacuum	6	45	30	7	1	1	4	1
SR-24A	24" x 24" x 36" 61.0 x 61.0 x 91.4 cm	Gravity	6	20	1	8	1	1	4	1
		Ejector	6	160	145	8	1	1	4	1
		Vacuum	6	55	35	8	1	1	4	1
SR-24B	24" x 24" x 48" 61.0 x 61.0 x 122.0 cm	Gravity	6	30	2	9	1	1	4	1
		Ejector	6	180	155	9	1	1	5	1
		Vacuum	6	60	35	9	1	1	5	1
SR-26A	26" x 26" x 39" 66.0 x 66.0 x 99.0 cm	Gravity	6	30	2	9	1	1	4	1
		Ejector	6	185	155	9	1	1	5	1
		Vacuum	6	60	35	9	1	1	5	1

Note: Consumption for Dual (Tower) models is generally extrapolated from single chamber data. Contact Consolidated for additional information.

Table 3, Power and Steam Usage

Model	Size (inches)	Air Removal Method	Electrically Heated				Steam Heated			
			Generator Size (KW)	Generator Current (Amps) ¹				Steam Consumption		
				208V	240V	380V	480V	Peak (lb/hr)	Per Cycle ³ (lb/cycle)	Idle (lb/hr)
SSR-2A	16" x 16" x 26" 40.6 x 40.6 x 66.0 cm	Gravity	24	67	58	36	29	180	17	5
		Vacuum	24	67	58	36	29	180	25	5
SSR-3A	20" x 20" x 38" 50.8 x 50.8 x 96.5 cm	Gravity	24	67	58	36	29	180	20	7
		Vacuum	24	67	58	36	29	180	35	7
SR-24A	24" x 24" x 36" 61.0 x 61.0 x 91.4 cm	Gravity	24	67	58	36	29	180	30	7
		Vacuum	30	83	72	46	36	180	50	7
SR-24B	24" x 24" x 48" 61.0 x 61.0 x 122.0 cm	Gravity	24	67	58	36	29	180	35	9
		Vacuum	30	83	72	46	36	180	55	9
SR-26A	26" x 26" x 39" 66.0 x 66.0 x 99.0 cm	Gravity	24	67	58	36	29	180	35	9
		Vacuum	30	83	72	46	36	180	55	9

Note: For Dual (Tower) models contact Consolidated for additional information.

Table 4, Water Feed Requirements, Carbon Steel Steam Generators*

Characteristic	Recommended Condition	Maximum Condition
Temperature	As Supplied	140°F
Total Hardness	0-17 mg/L	85 mg/L
T-Alkalinity	200-400 mg/L	500 mg/L
P-Alkalinity	85-250 mg/L	410 mg/L
pH	7.5-8.5	7.0-9.0
Total Silica	0.1-1.0 mg/L	2.5 mg/L
Resistivity	2000-6000 ohms/cm	26,000 ohms/cm ⁵

* Stainless Steel generators require distilled or deionized water > 1 MΩ/cm

¹ Assuming chamber fully loaded with flasks filled 25% with water.

² Hot water recommended for electric steam generators.

³ Assuming 30 minute sterilizing time at 250°F and 20 minute dry time.

⁴ Current drawn by generator. Local codes and regulations may affect breaker size.

⁵ If water supplied is greater than 26,000 ohms/cm contact Consolidated for recommendation.

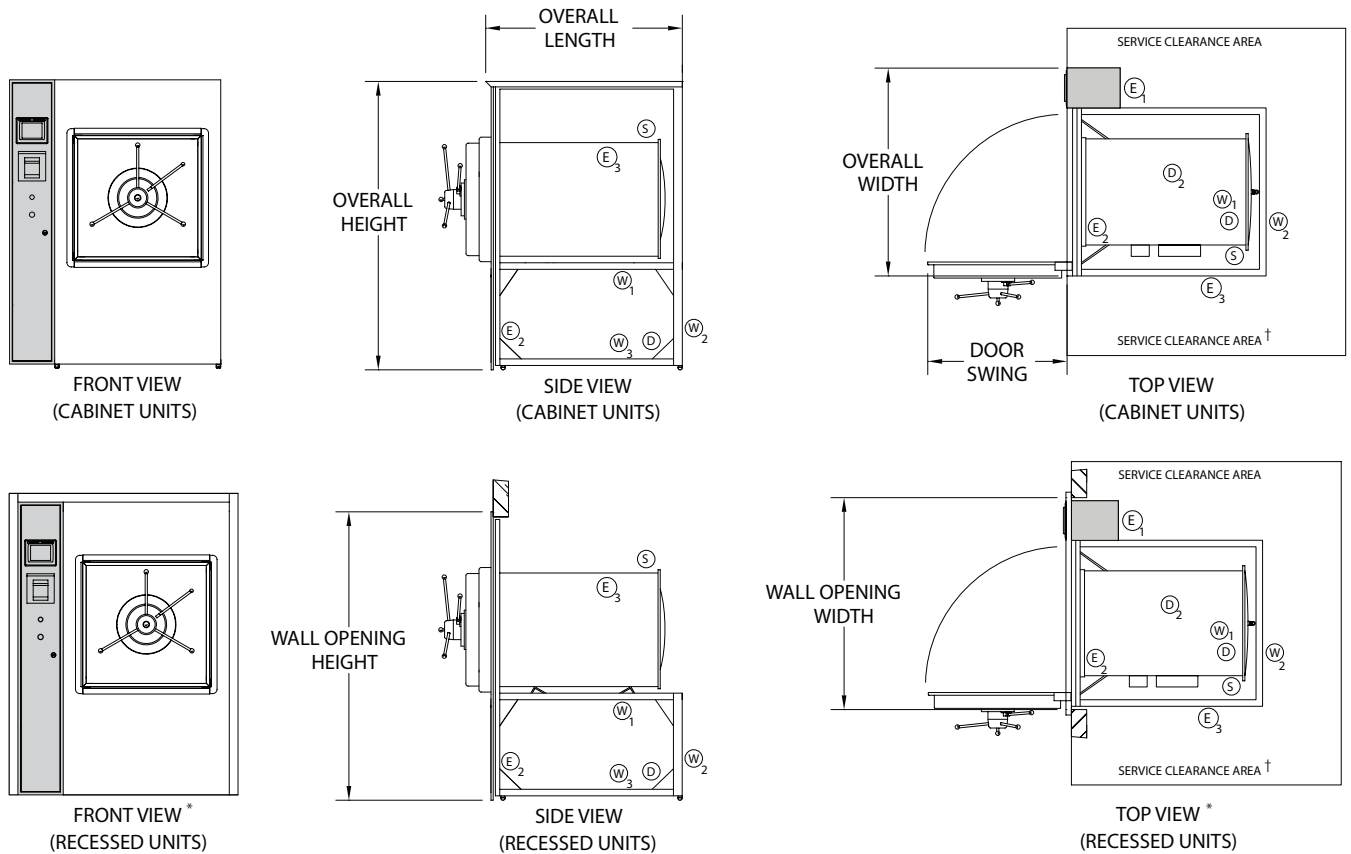

(E) Electrical (D) Drain (W) Water (S) Steam

Typical Utility Requirements

Steam (S): ½" NPT, 50-80 psi dynamic.

Electrical (E1, E3): 110V, AC or 220V, AC, 1-phase, 15 amps – dedicated and isolated.

Water (W2): ½" NPT, 45 psi dynamic minimum.

Drain (D): Open drain to funnel connection in floor, diameter 2½".

Water for Optional Vacuum Systems, Maximum One per Unit

Economy, Post-Vac (W3): ½" NPT, 45 psi minimum

Hi-Vacuum with Water Ejector (W3): 1¼" NPT, 45 psi minimum

Hi-Vacuum with Vacuum Pump (W3): ½" NPT, 45 psi minimum

Electric Steam Generator Utilities:

Power Supply (E2): available in 208/240/380/480V, single or three phase

Generator Feedwater (W1): hot/treated water, ½" NPT, 60 psi dynamic minimum

Model	SSR-2A	SSR-3A	SR-24A	SR-24B	SR-26A
Chamber Size (w x h x f-b)	16" x 16" x 26" 40.6 x 40.6 x 66.0 cm	20" x 20" x 38" 50.8 x 50.8 x 96.5 cm	24" x 24" x 36" 61.0 x 61.0 x 91.4 cm	24" x 24" x 48" 61.0 x 61.0 x 122.0 cm	26" x 26" x 39" 66.0 x 66.0 x 99.0 cm
Volume (cu.ft.)	3.9 cu.ft. 109 liters	8.8 cu.ft. 249 liters	12.0 cu.ft. 340 liters	16.0 cu.ft. 453 liters	15.3 cu.ft. 433 liters
Overall Width	38	38	46	46	48
Overall Height	71	71	71	71	71
Overall Length	42	42	42	54	44.5
Wall Opening Width*	39.5	39.5	47.5	47.5	49.5
Wall Opening Height	72	72	72	72	72
Door Swing	22.5	27	33.5	33.5	35.5

☐ Right side hinge, left side controls, shown. Opposite mounting is available upon request.

† Allow service clearance of 18-24" min. both sides and back.

* Alternative controller mounting options are available at no charge for installations into smaller wall openings. Contact Consolidated or your Consolidated Sales Representative to arrange a solution.



**CONSOLIDATED
STILLS & STERILIZERS**

**P.O. BOX 297 | 76 ASHFORD STREET | BOSTON, MA 02134-0003
P: 617.782.6072 | F: 617.787.5865 | CONSTERIL.COM | SALES@CONSTERIL.COM**